

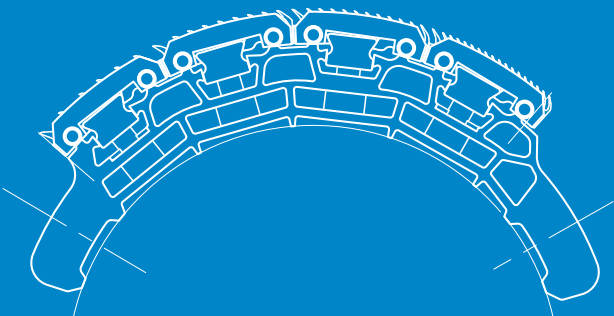

www.staedtleruhl.com

VARIO-Comb®

Combs for all types of
combing machines







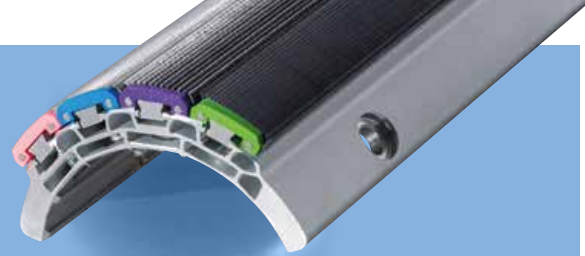





































Made in Germany

VARIO-Comb®







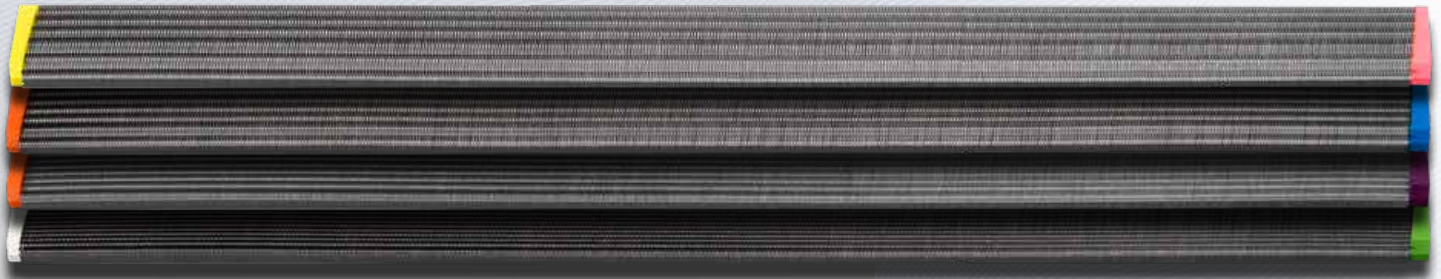













VARIO-Comb® Type

Row no.	9065	9075	1260	9225	9226
#1	 orange-black 	 orange-black 	 orange-black 	 yellow-pink 	 yellow-pink 
#2	 orange-yellow 	 orange-yellow 	 orange-yellow 	 orange-blue 	 orange-blue 
#3	 red-brown 	 red-brown 	 red-brown 	 orange-lila 	 orange-lila 
#4	 red-beige 	 blue-beige 	 red-beige 	 white-green 	 orange-green 
#5			 blue-beige 		
total amount of pins:	24.800	25.900	35.700	25.100	26.200



- Designed for all available combing machines of all machine manufacturers
- Specially designed basic body HP-type leading to higher stability and reduced comb weight
- Wide range of different pinning densities apart from standard combinations
- Fully hardened VARIO-Bars® to ensure high durability
- Easy to exchange VARIO-Bars® due to VARIO-Comb® fixation
- Long lifetime of the basic body for reduced costs of replacement

Colour codes of VARIO-Bars®

Order #	designation	colours		teeth rows	teeth per cm ²
5025	OR-SC		orange-black 	5	25
1025	OR-GE		orange-yellow 	10	62
1220	RO-BR		red-brown 	12	97
1520	RO-BE		red-beige 	15	125
1515	BL-BE		blue-beige 	15	139
6035C	GE-RS		yellow-pink 	6	32
9025C	OR-BL		orange-blue 	9	56
1225C	OR-LI		orange-lila 	12	97
1830C	WE-GR		white-green 	18	132
1825C	OR-GR		orange-green 	18	145

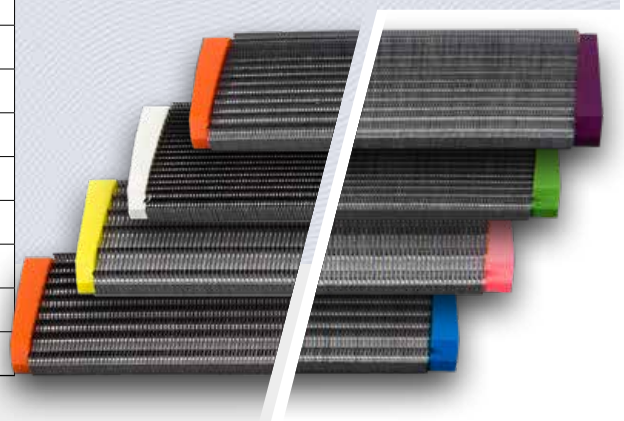

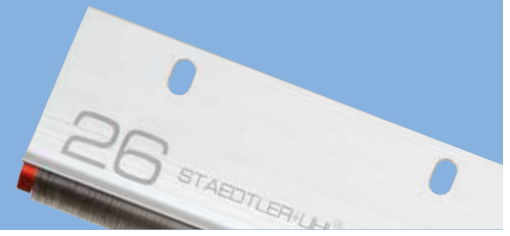

VARIOTOP® CL - Self cleaning top comb



up to 32 ppcm	pins/cm colour	
	23	Yellow
	26	Red
	28	Green
	30	Blue
	32	Black



- Special design for high speed combing machines
- Reduced weight
- Punched and specially hardened pins for long lifetime of the top comb
- Special bent shape of the pin
- Special surface treatment and polish of the pin for optimized combing results
- Drastically reduced cleaning frequency
- Reinforced ends of the pins for protection

VARIOTOP® - Self cleaning top comb



up to 35 ppcm	pins/cm	
	26	
	29	
	32	
	35	



- Punched and specially hardened pins for long lifetime of the top comb
- Special bent shape of the pin
- Special surface treatment and polish of the pin for optimized combing results
- Drastically reduced cleaning frequency
- Reinforced ends of the pins for protection
- Proven glueing technique for increased stability and secure fixation of the pins

VARIOTOP® HDX



up to 40 ppcm	Pinning densities	
	35/29	
	35/32	
	40/29	
	40/32	

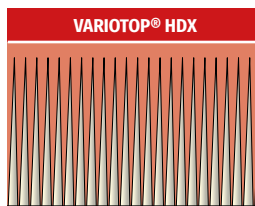
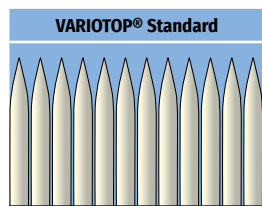

- Reduced wear and tear
- The increased number of pins provides a more effective distribution of the fibres
- Reduced strain onto the single pin
- Reduced free space between the pins compared to standard top combs
- The free space between two pins determines the cleaning efficiency
- Homogeneous combing due to increased specific free space
- Improved combing results of the combing sliver
- The free space between the pins corresponds to the pinning densities 29 or 32 pins/cm

VARIOTOP® Standard



up to 32 ppcm	pins/cm	
	23	
	26	
	28	
	30	
	32	



- The original standard top comb for numerous types of combing machines
- Also available for all machines of older make
- Proven glueing technique for increased stability and secure fixation of the pins

VARIO-TOP[®] - Top Comb Plates



torsion
free

VARIOTOP[®] XLS

- Special attached aluminium alloy stiffening bar for maximum increased stability for high speed combing
- Special synthetic material at contact areas
- High durability
- Special fixation of the reinforcement to the high quality aluminium alloy of the top comb plate
- Cobalt coloured surface for high resistivity

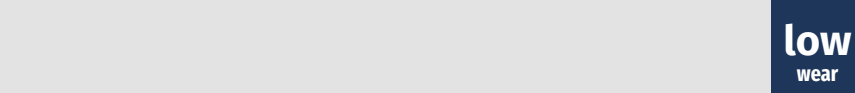

low
wear

VARIOTOP[®] XL

- Special synthetic material at contact areas
- Higher durability compared to FX
- Special fixation of the reinforcement to the high quality aluminium alloy of the top comb plate
- Cobalt coloured surface for high resistivity

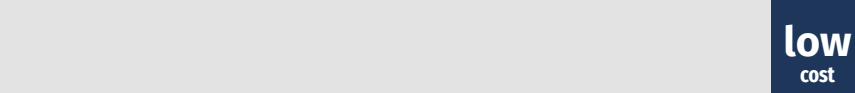

low
cost

VARIOTOP[®] FX

- Standard top comb plate made of high quality aluminium alloy
- High durability
- Cobalt coloured surface for high resistivity

Combine your **VARIO-TOP[®]** with the **TOP-Comb** of your choice.



VARIO-Comb®

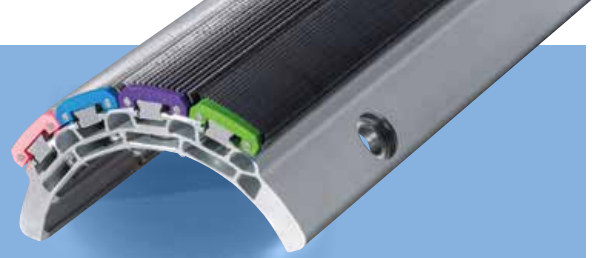

- Engineered to ensure highest capacities
- Quick exchange and fixation of the VARIO-Comb® Bars
- Reasonably priced for improved efficiency
- Made in Germany

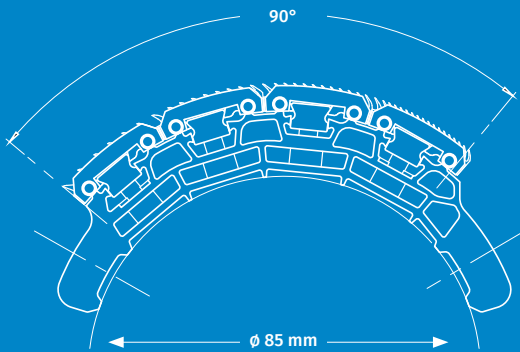

VARIO-Comb® HP 90°, ϕ 85 mm

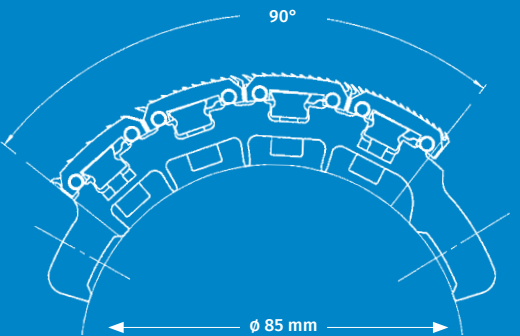
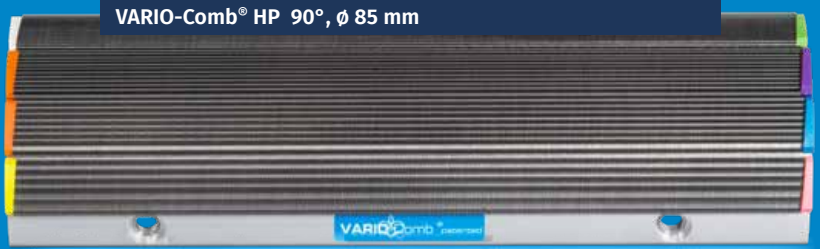

VARIO-Comb® Standard, 90°, ϕ 85 mm

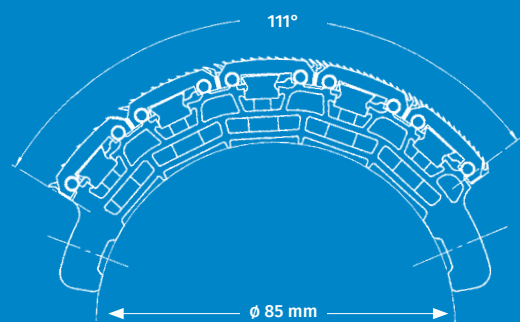

VARIO-Comb® HP 111°, ϕ 85 mm

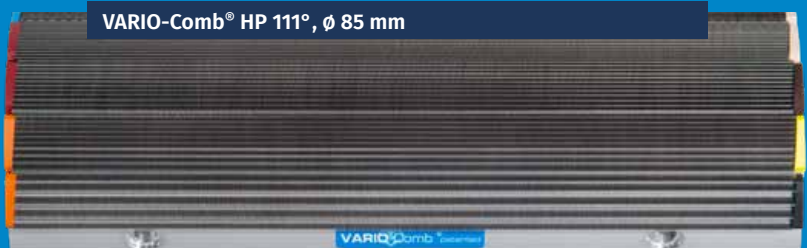

STAEDTLER+UHL

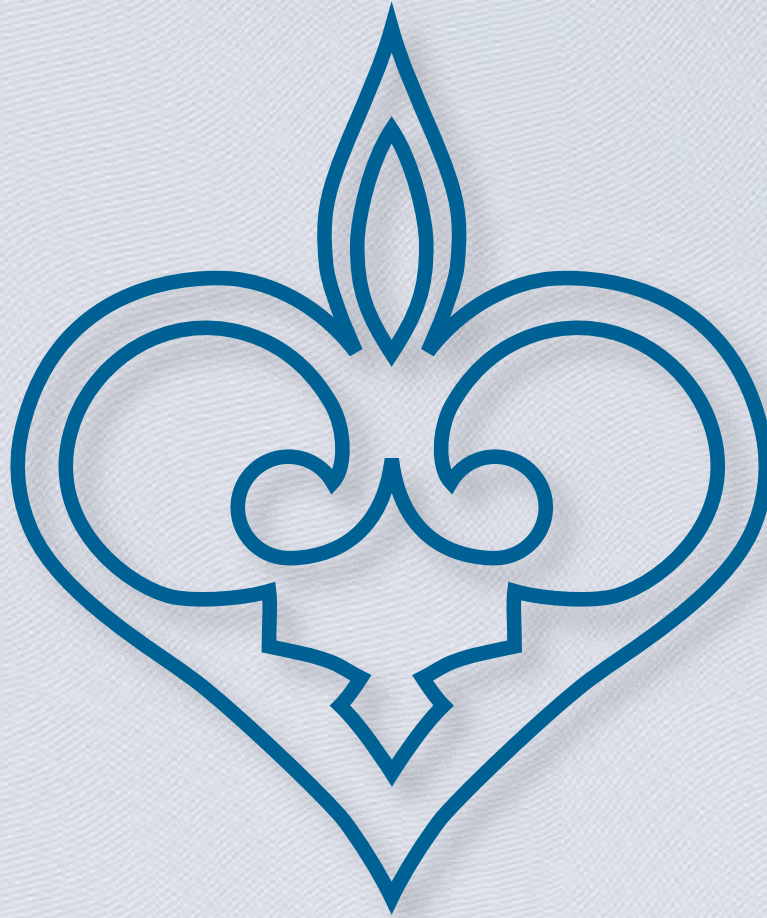

STAEDTLER + UHL KG

P.O. Box 2160

91111 Schwabach / Germany

Noerdliche Ringstrasse 12

91126 Schwabach / Germany

☎ +49.9122.1860 📠 +49.9122.186-28

✉ staedtler@staedtleruhl.com

🌐 www.staedtleruhl.com

Made in Germany