

**VARIO-Comb®**  
Circular Comb with Pin Strips  
Top Comb  
Feed Comb  
Accessories

**VARIO-Comb®**  
for wool, linen,  
silk and synthetic fibres

Decades of experience in the area of combing long staple fibres as for example wool, flax, linen, hemp, sisal, ramie, alpaca, cashmere, silk and synthetic fibres give STAEDTLER+UHL® a special know-how in the production of circular-, top- and feed combs. The experience of designing pins and pinned products for more than 225 years guarantees a maximum of quality and efficiency of produced combs.

Our high duty circular combs can be adapted to any combing machine without difficulty.

We offer two types of circular combs:

- VARIO  Comb with VARIO-bars
- Circular comb with pin strips



## System with Vario-bars

Colour codes of the VARIO-bars						
Order- Nr.	designation	colours	free space (in mm <sup>2</sup> )	free space per cm (in mm <sup>2</sup> )	number of teeth per cm <sup>2</sup>	
153	SC-SC	black	black	5,026	31,810	15,5
133	GR-SC	green	black	4,060	30,074	18,5
115	BL-SC	blue	black	3,220	28,000	21,5
110	RS-SC	pink	black	3,195	29,045	22,5
100	LI-SC	lila	black	2,590	25,900	25,0
090	RO-SC	red	black	2,355	26,167	27,5
080	OR-SC	orange	black	2,235	27,940	31,0
075	GE-SC	yellow	black	1,693	24,192	35,5
065	WE-SC	white	black	1,350	22,492	41,5
055	WE-WE	white	white	1,170	21,272	45,5
050	OR-WE	orange	white	0,975	19,504	50,0
045	BL-WE	blue	white	0,796	17,681	55,5
040	RS-WE	pink	white	0,631	15,782	62,5
035	RO-WE	red	white	0,452	12,096	71,5
030	GR-WE	green	white	0,318	10,594	83,5
025	GE-WE	yellow	white	0,184	7,356	100,0
F50	GR-GR	green	green	0,930	18,591	60,5
F45	BL-BL	blue	blue	0,720	15,990	67,5
F40	RO-RO	red	red	0,586	14,641	76,0
F35	GE-GE	yellow	yellow	0,452	12,906	87,0

- 1 = countersunk screw
- 2 = starting bar
- 3 = starting bar holder
- 4 = starting bar cover
- 5 = T-shaped clamping bar
- 6 = VARIO-bar
- 7 = segment basic body

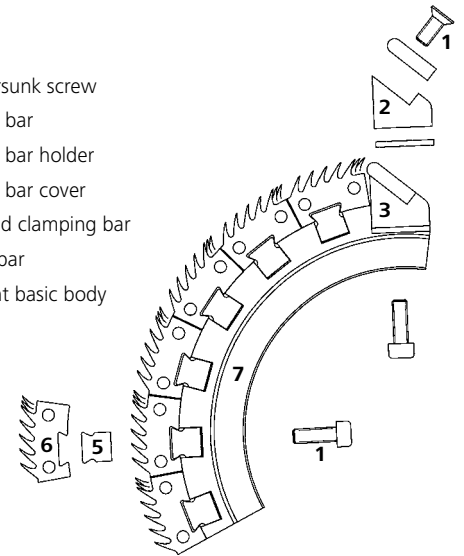

The system of our VARIO-Comb, which had been introduced to the textile industry more than 30 years ago, is based on the separation of the circular comb into a basic body and individually, easily mountable VARIO-bars.

According to the customer's technical specifications as for example fibre type, staple length and type of combing machine our technical department will recommend a combination of bars fulfilling the customer's requirements.

## System with Vario-bars for ERA combers

Colour codes for VARIO-bars – ERA					
Part- No.	colours	number of teeth rows	points per cm <sup>2</sup> (on the average)	points per inch <sup>2</sup>	
W 08 OR-RS	orange	pink	8	51,79	334,15
W 10 OR-GE	orange	yellow	10	64,74	417,69
W 10 GU-GE	grey	yellow	10	59,56	384,27
W 12 OR-BR	orange	brown	12	94,05	606,74

Our VARIO-Comb for the NSC ERA-combers also combines all the advantages of our Vario-System. For ERA-combers our VARIO-Comb consists of a basic body with a 360° combing section and removable Vario-bars.

The pinning density can be offered according to the customer's requirement.

### Machine Types

**All current types of combing machines can be equipped with our VARIO-System:**

NSC PB 25 – PB 33, ERA, Sant'Andrea P90 + P100, PSE, PSD, Millenium, Textima 1601, 1602, 1603, 1604, 1605, 1606, other machines on demand

# Circular Comb with Pin Strips



Pinning Densities		
pins/cm		
4	6	7
8,5	10	11
12	14	15
16	17	18
19	20	21
22	24	25
28	30	32

Two executions are available; the difference is the height of the lateral sheet as shown:

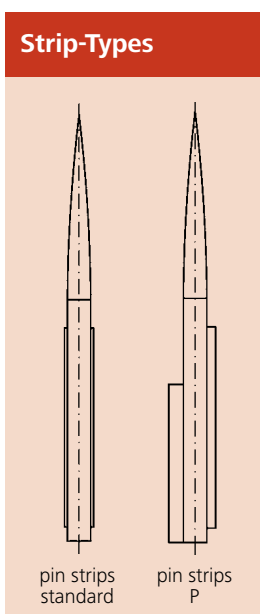

Apart from the VARIO-system for circular combs we continue to offer the option of combining VARIO-bars and circular comb pin strips.

The replacement of the circular comb pin strips is also very easy. Simply loosen the screws of a clamping bar and then tighten the forcing screws until the bar between the two strips can be moved. Then lift the strip a little and pull it sideways to replace it.

Besides the complete basic body we also offer all parts belonging to it as spare parts, for example starting bars, clamping bars and fixing screws. On request we will produce several types of pin strip segments for any kind of combing machine.

- 1 = fixing crew
- 2 = forcing screw
- 3 = clamping bar
- 4 = pin strip
- 5 = basic body

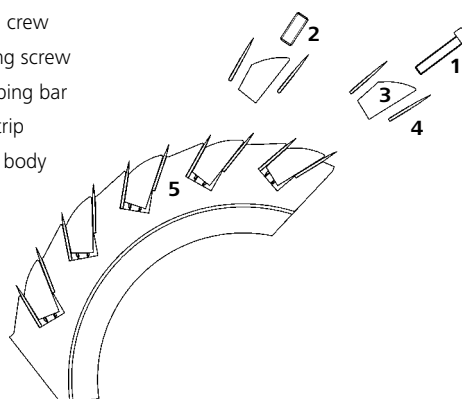

# Top Comb – Standard and VARIOTOP WT

## Top Comb Standard

As original equipment supplier for numerous combing machine manufacturers we rely on our experience of producing and developing top comb pin strips for decades. Of course we also produce and deliver top combs for all machine types on the market, especially also for older combing machines.



## VARIOTOP WT

### Extended Lifetime

The new top comb VARIOTOP WT stands out due to reduced wear and tear since the increased number of pins per cm provide a more effective distribution of the fibres and thus a reduced strain onto the single pin.

### Improved Combing Result

The free space between two pins determines the cleaning efficiency. Compared with standard top combs the free space between two pins of the VARIOTOP WT is reduced by 10%. This leads to an improved combing result of the combed sliver.

### Reduced Cost

The increase by 18% of the specific free space in the top comb ensures homogenous combing and better performance of the machines.

### Pinning Densities and Projections

pins/cm	projection (in mm)		
	8,2	9,2	10,2
16	8,2	9,2	
18	8,2	9,2	10,2
21	8,2		10,2
23	8,2		10,2
25	8,2	9,2	
26	8,2	9,2	
28	8,2	9,2	
30	8,2	9,2	
32	8,2		

### Machine Types

**All current types of combing machines can be equipped with our VARIOTOP WT:**  
 NSC PB 25 – PB 33, ERA,  
 Sant'Andrea P90 + P100, PSE, PSD, Millenium,  
 Textima 1601, 1602, 1603, 1604, 1605, 1606,  
 other machines on demand

### Available Pinning Densities

**VARIOTOP WT 35/28, 35/30, 35/32**

(corresponds to standard top combs with 28, 30, 32 pins per cm)

### View through the microscope

left side: pins of Top Comb Standard  
 right side: pins of Top Comb VARIOTOP WT

The top comb VARIOTOP WT is always equipped with 35 pins per cm. However, the free space between the pins corresponds to the pinning densities 28, 30 or 32 pins per cm of the standard top comb actually used.

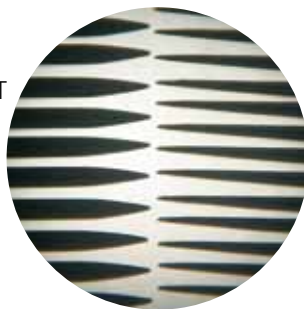

# Feed Comb



In addition to the circular comb and the top comb we are also producing feed combs as the third pinned product for combing machines.

Besides the completely pinned feed comb plate and the feed comb pin strips we offer all matching spare parts, for example wedges, dampers and fixing screws – of course also for older models of combing machines.

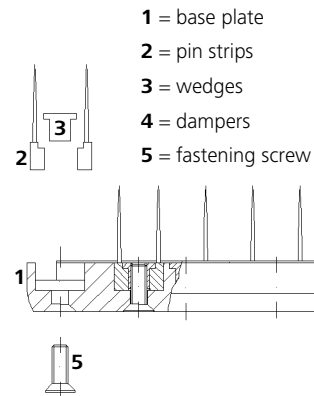

## Accessories

In addition to our main products we also offer the full range of matching spare parts like starting bars, clamping bars, fixing screws, wedges, dampers, clamps, etc.

Furthermore, we offer pin strips for all kinds of testing device and various spare parts for processing linen fibres.

### Feed Comb Pin Strips



Trapeze Type



P-Type



Metal Pin Strips

The feed comb pin strips are available in two different designs: plastic base in „trapeze“ form and plastic base in „P“ form. On request we continue to produce metal strips for older combing machines.

### Pinning Densities (pins/cm)

Trapeze Type	P-Type	Metal Pin Strips
5	5	5
6	6	6
7	7	7
	8	
8,5	8,5	

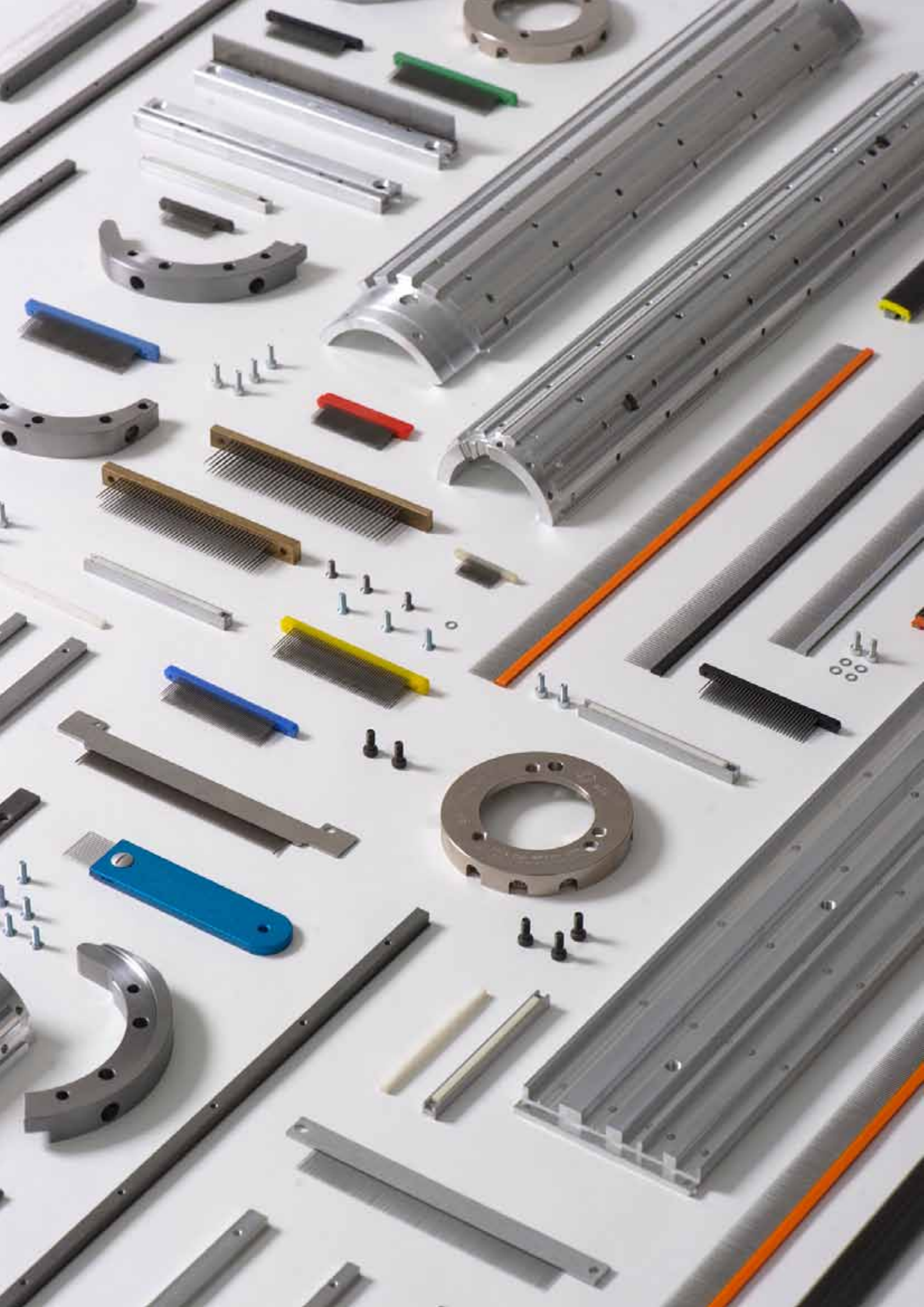

For more than 225 years we have been producing pins and pinned systems for the textile industry. Our products are used when processing different natural fibres as for example wool, cotton and linen and also for synthetic fibres. Further key points are pins and pin plates for textile finishing and temple pins.

# VARIO Comb<sup>®</sup>

STAEDTLER + UHL KG  
P.O. Box 2160  
D-91111 Schwabach/Germany  
Noerdliche Ringstrasse 12  
D-91126 Schwabach/Germany  
Phone: (+49) 09122 / 186-0  
Fax: (+49) 09122 / 186-28  
staedtler@staedtleruhl.com

**[www.staedtleruhl.com](http://www.staedtleruhl.com)**

 **Made in Germany**